

a personal guide to

M A N A G I N G

Chest Drainage

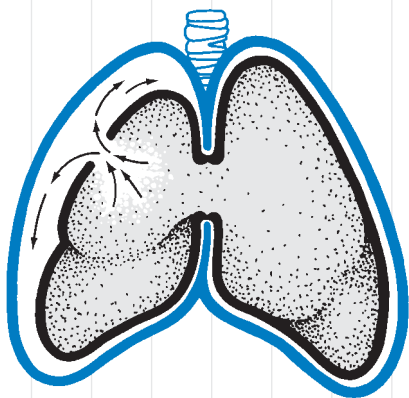

ATRIUM

Table of Contents

Your personal guide to *Managing Chest Drainage* is a quick and easy reference to help extend your understanding of chest tube drainage and to help answer questions which may come up from time to time. It is provided as an educational service of Atrium, the leading producer of chest drainage systems. This booklet has been prepared as an educational aid only and is not intended to replace any medical or nursing practices or hospital policies. Due to numerous model types available, it is important to carefully read and follow each corresponding product insert prior to use.

Introduction

Making It Simple To Understand	4
--------------------------------------	---

How Water Seal CDUs Function

The Basic Operating System	5
Fluid Collection	6
Water Seal	6
Suction Control	7

The Atrium System

Timeless Design	8
Features, Benefits, Function	10
Product Feature Summary	12

System Set Up

Open Package	14
Requirements For Set Up	14
Four Step Set Up	14

What To Check During System Operation

Suction Control Stopcock	18
Verifying System Operation	18
Placement Of Unit	19
Observing Water Seal For Patient Air Leaks	19

Graduated Air Leak Monitor	19
Observing Changes In Patient Pressure	20
Atrium's High Negativity Float Valve	20
Manual High Negativity Vent	21
Positive Pressure Protection	21
Adding Water To Water Seal	21
Adding Water To Suction Control	21
To Prescribe Suction Pressure	
Greater Than -20cmH ₂ O	21
To Lower Suction Control Pressure	22
Recording Drainage Volume	22
In-Line Patient Tube Connector	22
Patient Tube Clamp	22
Sampling Patient Drainage	23
Swing Out Floor Stand	23
Multi-Position Hangers	23
Gravity Drainage	23
System Disconnection	23

Anatomy And Physiology Review

Anatomy Of The Chest	24
Why The Lungs Are Expanded	25
The Mechanics Of Breathing	26

Why Water Seal CDUs Are Used

Clinical Needs For Chest Tube Drainage	27
--	----

Problems To Check For During CDU Use 30

Chest Tube Placement

Chest Tube Insertion	31
Chest Tube Nursing Responsibilities	32

Troubleshooting Guide

Questions And Answers	33
---------------------------------	----

Introduction

■ Making It Simple To Understand

To restore the chest to its normal condition, all air and fluid must be removed, and the source of an air leak must be closed. The purpose of any chest drainage device is to help re-establish normal vacuum pressures by removing air and fluid in a closed, one-way fashion.

The need for chest drainage is also required following open heart surgery and chest trauma to evacuate any pooling blood which, if left in the mediastinal cavity, can cause cardiac distress or tamponade. Hence, chest drainage is indeed a life-saving procedure and one of the most important services a physician and nurse clinician can render.

While the practical application of water seal chest drainage techniques are relatively simple, sometimes the chest drain and its accompanying terminology may appear complex. However, water seal chest drainage systems are actually quite simple to manage and easy to understand. It is our hope that review of this educational aid booklet will help enhance your working knowledge of chest drainage and further familiarize you with Atrium's traditional water seal operating system.

■ Customer Service

If a question or need arises for customer service, product information, or to request inservice educational material, we invite you to call or FAX Atrium's hotline anytime.

In the U.S.A. 1-800-528-7486
Outside the U.S.A. 603-880-1433
FAX 603-880-6718
www.atriummed.com

How Water Seal CDU's Function

■ The Basic Operating System

Today's water seal drainage systems are comprised of a one-piece, 3-chamber setup, which provides separate functions of *fluid collection*, *water seal* (which serves as a simple one-way valve), and *suction control*. An easy way to describe the one-way action of a water seal is to refer to a cup of water and a straw. If one were to blow air into a submerged straw, air would bubble out through the water. Now if you wanted to draw the air back through the straw, you would only draw water. Hence, when chest drainage came into light many years ago, the one-way action of a water seal (water bottle and straw concept) provided a simple but ideal means for evacuating air and not allowing it to return to the patient.

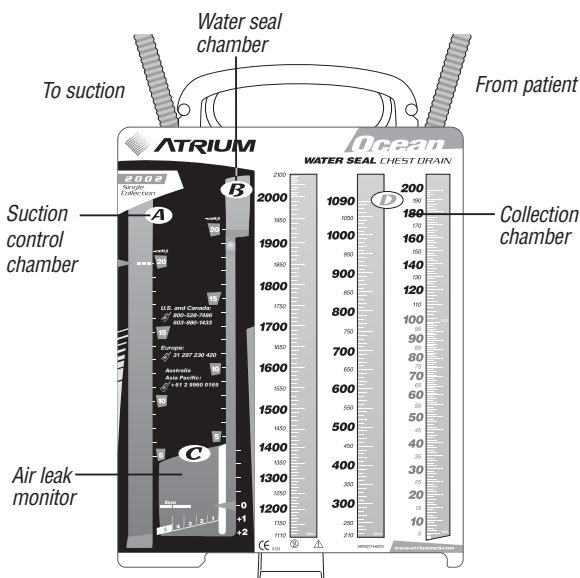

To this day, nothing is more consistent, accurate, or as dependable as water and gravity. Consequently, today's water seal operating systems not only provide a simple method to maintain a required amount of vacuum in a patient's chest, but now provide more patient diagnostics, improved air leak detection, high negative pressure protection, and options for autotransfusion.

■ Fluid Collection

In a traditional water seal operating system, fluids drain from the patient directly into a large *collection chamber* via a 6-foot patient tube (3/8" I.D.). As drainage fluids collect in this chamber, the nurse will record the amount of fluid that collects on a specified schedule. Hence, an easy-to-read, well calibrated collection chamber is one of the most important features for any new chest drainage system.

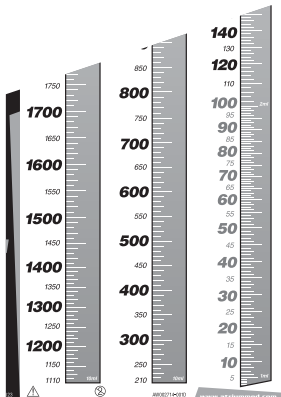

■ Water Seal

The *water seal chamber*, which is connected in series to the collection chamber, allows air to pass down through a straw or narrow channel and bubble out through the bottom of the water seal. Since air must not return to the patient, a water seal is considered one of the safest and cost effective means for protecting the patient, in addition to being a very useful diagnostic tool. The water seal column is calibrated and acts as a water manometer for measuring intrathoracic pressure. As changes in intrathoracic pressure occur, fluctuation in the water level can be



observed in this calibrated column. Such fluctuations provide the clinician an indication of how the patient is progressing. With the addition of an advanced float valve at the top of the water seal, a patient can also be protected from the dangers of accumulating high vacuum pressures or high negativity, which can be induced from chest tube stripping or milking. Today's more sophisticated systems provide such patient protection both manually and automatically.

■ Suction Control

The use of suction helps overcome an air leak by improving the rate of air and fluid flow out of the patient. The simplest and most cost effective means of controlling suction is by a calibrated water chamber. This is accomplished with a *suction control chamber*, which is an atmospherically vented section containing water and is connected in series with the water seal chamber and collection chamber. By adding or removing water in the suction control chamber, the chest drain effectively controls the amount of suction imposed on the patient. The lower the water content, the lower the imposed suction. The higher the water level, the higher the imposed suction.



The Atrium System

■ Timeless Design

From the beginning, Atrium has pioneered advances in water seal design with compact chest drains that are smaller, user friendly, and cost effective. We've continued our commitment to product innovation with the latest series of Ocean™ water seal chest drains featuring a familiar water seal operating system with convenient ATS compatibility, essential for today's hospital-wide standardization needs.

- *Compact, lightweight unit is easy to handle, convenient to transport, and sets up in seconds.*
- *Large, easy-to-read collection chamber numbers and graduations provide the ultimate in patient drainage assessment.*
- *Proven water seal design features maximum knock-over protection.*
- *Blue tint water seal and suction control chambers offer enhanced visibility for tracking patient air leaks and verifying suction level.*
- *Suction control stopcock provides quieter operation, superior operating efficiency, and improved evaporation protection.*
- *Advanced float valve design provides automatic high negative pressure relief.*
- *Filtered manual vent offers optimum protection when reducing patient pressure.*
- *Available with in-line patient tube connectors for convenient change out or rapid in-line ATS bag use.*

Manual High
Negativity Vent

100%
LATEX-FREE

Water Seal
Chamber

Positive Pressure
Release Valve

Easy-to-Grip
Handle

In-line
Connector

Multi-
Position
Hangers

Suction
Control
Chamber

Collection
Chamber

Air Leak
Monitor

Patient
Pressure
Float Ball

Swing Out
Floor Stand

Patient
Connector

Patient
Tube
Clamp

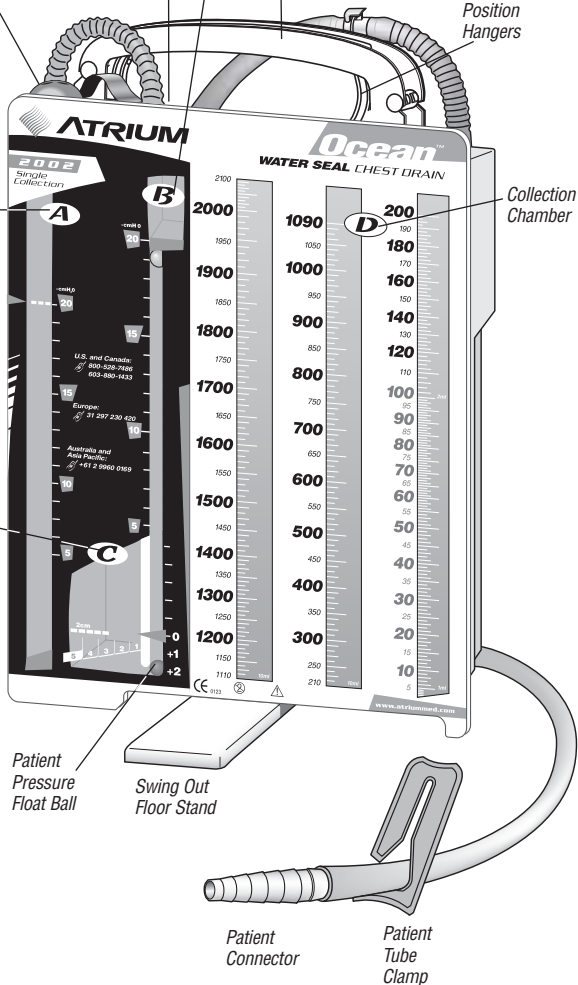

■ Suction Control Stopcock

Available on most Atrium models, this high quality, large lumen stopcock provides effective control of vacuum to the drain for more efficient system operation. Simple to use and operate, it can be adjusted at bedside to increase or decrease suction control bubbling or simply “quiet down” the chest drain with soft, gentle bubbling. With Atrium’s unique suction control stopcock, multiple drainage units can be connected to a single suction source, providing effective

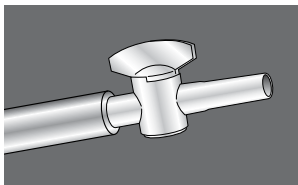

control of bubbling for each. For the first time, a traditional water seal CDU can be safely and conveniently connected to unregulated vacuum anywhere in the hospital.

■ Advanced Water Seal Technology

At the heart of every Atrium water seal chest drain is an advanced water seal design. Patient air leak assessment and system integrity are enhanced with Atrium’s blue tint water seal and superior knock-over protection. The fully calibrated water seal also provides more convenient patient pressure diagnostics and features our exclusive automatic high negative pressure relief. Together with a new, ergonomically designed filtered manual vent, patients now have the utmost protection from accumulating vacuum pressure.

■ Superior Air Leak Detection

All Atrium water seal products feature a patient pressure float ball for monitoring changes in intrathoracic pressures. With Atrium’s graduated air leak monitor at the bottom of the water seal, intermittent as well as continuous air leaks can be readily confirmed. When water is added to the water seal,

the water will turn blue. This enhanced visibility of Atrium's water seal makes monitoring patient air leaks quick and easy when bubbling is present in the graduated air leak monitor.

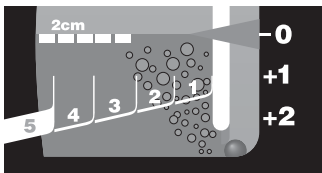

■ Proven Float Valve Design

Atrium's high negativity float valve with its unique controlled release action enables any thoracic patient to draw as much intrathoracic pressure as is required during each respiratory cycle. During prolonged episodes of extreme negative pressure (as with chest tube stripping), Atrium's controlled release system will automatically relieve excessive vacuum to a lower level.

■ Filtered Manual Vent

Atrium's filtered manual vent, conveniently located on top of the drain, is tamper-resistant, unobtrusive, and easy-to-use. Designed for use when connected to suction, temporary depression will lower height of water seal column and patient pressure.

■ Convenient System Disconnection And Options For Autotransfusion

On models equipped with in-line connectors, Atrium offers unlimited flexibility for prescribing post-op autotransfusion at any time. These tamper-resistant, locking patient tube connectors provide convenient system disconnection after use or rapid in-line ATS blood bag attachment, when required.

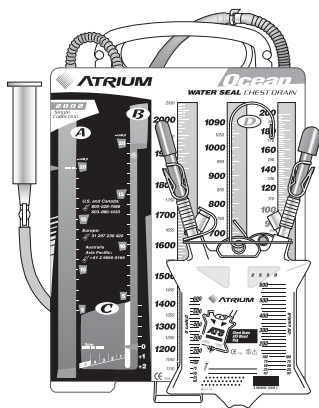

■ Atrium Product Feature Summary

Feature	Benefit	Function
• Pre-Attached Funnel	• Quick and easy set up.	• No more overfilled or underfilled water seals. Pull forward and down. Fill funnel to top, raise to empty water into drain.
• Suction Control Stopcock	• Simple and convenient suction regulation.	• Stopcock provides safe and efficient control for constant gentle bubbling with either regulated or unregulated suction.
• Advanced Blue Tint Suction Control Chamber	• Quiet, more efficient operation offers maximum evaporation protection.	• Unique aeration and condensation rib design reduces vibration and channels water energy. Verifying suction level is more convenient with blue tint water.
• Blue Tint Water Seal	• More efficient air leak detection and convenient monitoring of patient pressure.	• Water seal turns blue when filled, improves visibility.
• Graduated Air Leak Monitor	• Fast, easy detection and monitoring of patient air leaks.	• Air leak bubbling can range from 1 (low) to 5 (high) for monitoring patient air leak trends.
• Patient Pressure Float Ball	• Instant patient pressure verification.	• The small, highly visible float ball clearly identifies the height of the water seal column.
• High Negativity Float Valve	• Advanced design provides maximum patient protection during deep inspiration and gravity drainage.	• Allows the thoracic patient to draw as much intrathoracic pressure as required to complete respiration while maintaining the integrity of the water seal.
• Filtered Manual Vent	• Preferred ergonomic design is easy to use and offers maximum filter protection.	• Provides effective manual vent control when lowering height of water seal column.
• High Negative Pressure Protection	• Advanced float valve automatically vents high vacuum.	• Unique valve design offers a controlled release during episodes of prolonged high negative pressure.
• Positive Pressure Protection	• Tamper resistant positive pressure relief valve automatically protects patient from accumulating positive pressure.	• Integral to the system, this valve automatically prevents tension pneumothorax during accidental suction line occlusion.

Feature	Benefit	Function
<ul style="list-style-type: none"> • Autotransfusion Capabilities 	<ul style="list-style-type: none"> • Atrium provides numerous options for emergency or post-op autotransfusion on demand. 	<ul style="list-style-type: none"> • Fast, convenient ATS bag use or continuous ATS via infusion pump.
<ul style="list-style-type: none"> • In-Line Connector 	<ul style="list-style-type: none"> • Smooth, low profile design has audible locking mechanism. 	<ul style="list-style-type: none"> • Connector provides convenient system disconnection or fast in-line ATS bag attachment.
<ul style="list-style-type: none"> • Patient Tube Slide Clamp 	<ul style="list-style-type: none"> • Maximum patient protection during patient tube detachment. 	<ul style="list-style-type: none"> • Provides secure patient tube occlusion during system disconnection or ATS bag use. Slide clamp design prevents inadvertent closure.
<ul style="list-style-type: none"> • Collection Chamber Graduations 	<ul style="list-style-type: none"> • Improved collection chamber design is easier to read. 	<ul style="list-style-type: none"> • Large collection window graduations provide fast and accurate volume assessment.
<ul style="list-style-type: none"> • Maximum Knock-over Protection 	<ul style="list-style-type: none"> • Fully recoverable water seal offers maximum patient protection. 	<ul style="list-style-type: none"> • Water seal integrity is preserved during transport and accidental knock-over, even when connected to suction.
<ul style="list-style-type: none"> • Easy-to-Grip Handle 	<ul style="list-style-type: none"> • Comfortable design facilitates hand-off. 	<ul style="list-style-type: none"> • Makes patient ambulation and patient transport safer and more practical than before.
<ul style="list-style-type: none"> • Flexi-Hangers 	<ul style="list-style-type: none"> • Accommodates today's newer bed designs. 	<ul style="list-style-type: none"> • Flexible hangers (located inside the handle) allow drain to be hung from a single point.
<ul style="list-style-type: none"> • Swing Out Floor Stand 	<ul style="list-style-type: none"> • Secure system placement during set up or on floor. 	<ul style="list-style-type: none"> • Floor stand conveniently swings out for maximum stability, closes for transport.
<ul style="list-style-type: none"> • Complete Product Line 	<ul style="list-style-type: none"> • Atrium produces many chest drain models for hospital-wide standardization, including dual collection, pediatric, and numerous ATS models. 	<ul style="list-style-type: none"> • Atrium offers maximum cost efficiency with superior quality, and options for ATS, all with a familiar water seal operating system.

System Set Up

■ Open Package

Remove the unit from the outer bag. Atrium chest drains are wrapped in high quality CSR wrap and should be opened following hospital approved sterile technique.

■ Requirements For Set Up

A maximum of 500cc of water will be required. Determine hospital's protocol for type of water to be used for each model or procedure (*sterile saline or sterile water*). *Sterile saline is recommended for all continuous ATS applications.*

■ Four Step Set Up

Swing floor stand open for set up. For models equipped with an in-line connector, move the patient tube clamp closer to the chest drain (next to the in-line connector) for set up convenience and patient safety. For those models equipped with a suction control stopcock, it must be ON during system set up. Follow steps 1-4 and refer to each model's product insert for additional details concerning system set up, operation, instructions for use, and warnings and cautions.

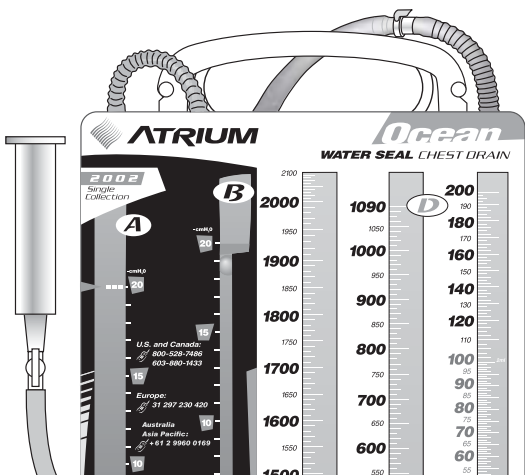

■ Step 1

Fill Water Seal (B) To 2cm Line

Position funnel as shown and add water to *top* of funnel. Raise funnel to empty water into water seal to 2cm line.

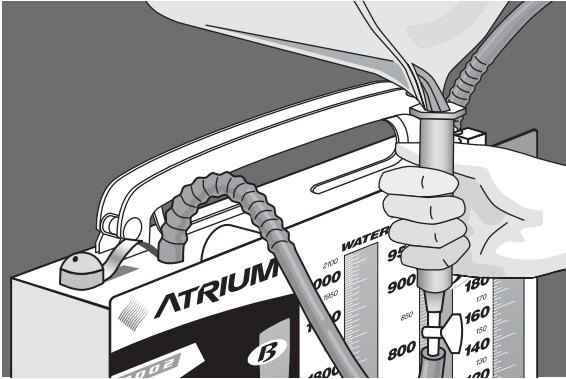

Once filled, water becomes tinted blue for improved visibility of air leaks and convenient monitoring of patient pressures. Remove the funnel and discard after use. Do not overfill water seal above 2cm line. If necessary, remove excess with 20 gauge or smaller needle and syringe through grommet located on the back.

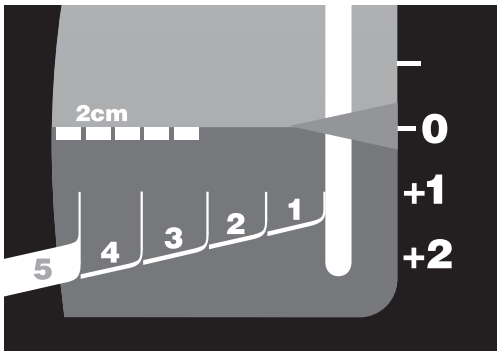

■ Step 2

Fill Suction Control **(A)**

To fill suction control chamber to desired suction pressure level (-20cmH₂O), remove the tethered vent-plug, pour water, and replace vent-plug. Once filled, water becomes tinted blue.

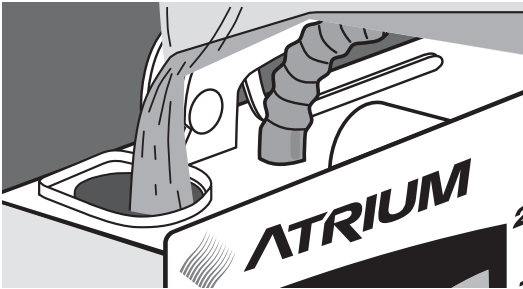

■ Step 3

Patient Connection

Remove patient tube connector cap and insert stepped connector into patient catheter(s). Remove or cut off stepped connector for "Y" connector insertion. If desired, use of nylon bands around catheter and patient tube connections will provide added security and assure an air-tight connection. The chest drain should be connected to the patient *prior* to initiating suction.

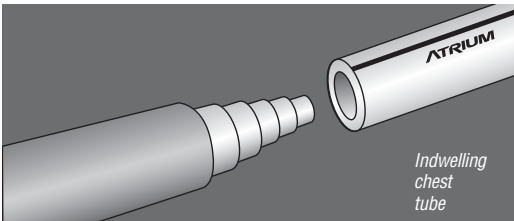

■ Step 4

Applying Suction

All Atrium chest drainage systems will operate with either portable pump or wall suction commonly used for chest drainage. To apply suction, connect suction source line directly to the suction control stopcock or suction connector provided.

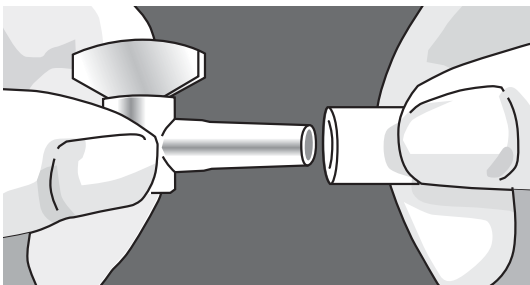

Connecting To Regulated Suction

When applying suction from either a wall regulator or pump to models equipped with a suction control stopcock, slowly increase suction source pressure until constant, gentle bubbling occurs in suction control chamber. Adjust the suction control stopcock or suction control source as needed to increase or decrease suction control bubbling.

Connecting To Unregulated Suction

When applying wall suction without a wall regulator to models equipped with a suction control stopcock, turn the stopcock to the OFF position *prior to* connecting suction source to chest drain. Once connected, use the suction control stopcock to slowly increase suction until constant, gentle bubbling occurs in suction control chamber. Adjust stopcock as needed to increase or decrease suction control bubbling.

What To Check During System Operation

■ Suction Control Stopcock

Atrium's suction control stopcock conveniently regulates vacuum to the chest drain. It provides effective control of suction control bubbling and allows efficient use with any unregulated suction source. The stopcock must be ON for initial system setup and should not be turned OFF during patient use.

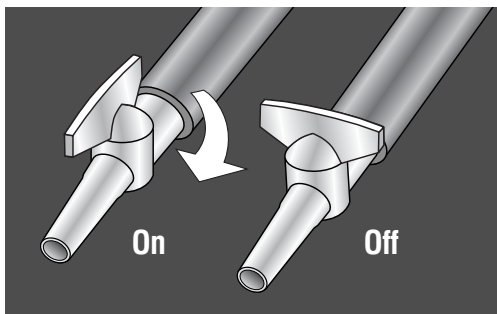

■ Verifying System Operation

Water seal and suction control chambers must be filled and maintained to prescribed levels to ensure proper operation and should be checked regularly when used for extended periods. Water seal should be maintained at 2cm line and suction control chamber should bubble **gently** when connected to suction. Adjust stopcock or suction source as needed to increase or decrease suction control bubbling.

■ Placement Of Unit

For optimum drainage results, always place the chest drain *below* the patient's chest in an upright position. To avoid accidental knock-over, it is recommended to swing the floor stand open for secure placement on floor or to hang system bedside with the hangers provided. Atrium's unique water seal design provides maximum knock-over protection against inter-chamber siphoning events, accidental spillover, and does not allow unrestricted atmospheric air back to the patient when kept in an upright position.

■ Observing Water Seal For Patient Air Leaks

Atrium Ocean™ chest drains offer rapid air leak assessment and improved visibility due to the tinted water. A patient air leak is confirmed when air bubbles are observed going from right to left in the air leak monitor.

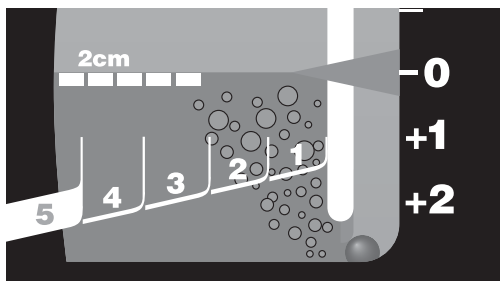

Continuous bubbling in the water seal air leak monitor will confirm a persistent air leak.

Intermittent bubbling with float ball oscillation will confirm the presence of an intermittent air leak.

No bubbling with minimal float ball oscillation at bottom of water seal will indicate no air leak is present.

■ Graduated Air Leak Monitor

For those models with a graduated air leak monitor, air leak bubbling can range from 1 (low) to 5 (high). Air bubbles create an easy to follow air leak pattern for monitoring patient air leak trends.

■ Observing Changes In Patient Pressure

Changes in patient pressure can be determined by observing the small patient pressure float ball in the calibrated water seal column. When connected to suction, patient pressure will equal suction control setting *plus* the float ball level. For gravity drainage, patient pressure will equal the float ball level only.

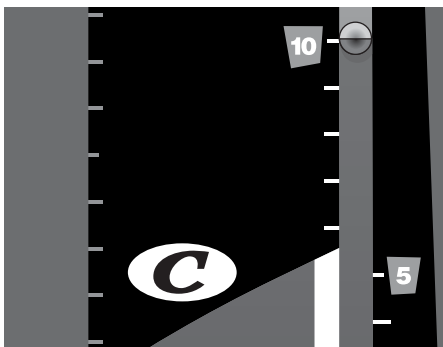

■ High Negativity Float Valve

Atrium's high negativity float valve, with its controlled release action, enables any thoracic patient to draw as much intrathoracic pressure as is required during each respiratory cycle. During prolonged episodes of extreme negative pressure, Atrium's controlled release system will automatically relieve excess vacuum to a lower, more desirable pressure level.

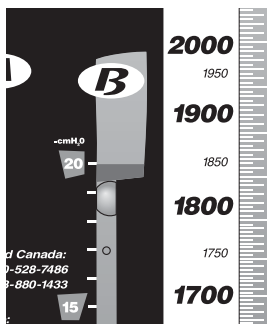

■ Manual High Negativity Vent

To manually lower the height of the water seal column or patient pressure when connected to suction,

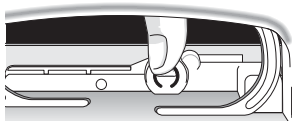

Do not use when suction is not operating

temporarily depress the filtered manual vent, located on top of the drain, until the float valve releases and the water column lowers to the desired level. **Do not lower water seal column when suction is not operating or when patient is on gravity drainage.**

■ Positive Pressure Protection

Atrium's positive pressure release valve, located on top of the drain, opens instantly to release accumulated positive pressure. Integral to the system, this advanced valve design is tamper-resistant and offers maximum air flow. **Do not obstruct the positive pressure relief valve.**

■ Adding Water To Water Seal

As required, additional water may be added using a 20 gauge or smaller needle and syringe via the grommet on the back. Simply fill to 2cm line.

■ Adding Water To Suction Control

As required, additional water may be added to the suction control chamber by **temporarily** turning suction source off or by turning stopcock to the OFF position. Add water to desired pressure level and slowly resume suction or slowly turn the stopcock back on to resume gentle bubbling in the suction control chamber.

■ To Prescribe Suction Pressure Greater Than $-20\text{cmH}_2\text{O}$

Suction pressure greater than $-20\text{cmH}_2\text{O}$ can be imposed directly by a calibrated wall regulator or portable pump by simply taping over the vent plug with non-porous tape and reading vacuum pressure directly from regulator or pump. **Vacuum pressures greater than -40mmHg are not recommended.**

■ To Lower Suction Control Pressure Setting

To lower suction pressure setting, turn the suction source OFF, remove water by syringe to desired pressure level via the grommet on the back, and resume suction.

■ Recording Drainage Volume

The collection chamber incorporates a writing surface with easy-to-read fluid level calibrations. Please refer to individual product for specific calibrations.

■ For Models Equipped With In-Line Patient Tube Connector(s)

The locking in-line patient tube connector provides convenient system replacement, simple disconnection after use, or rapid in-line ATS blood bag

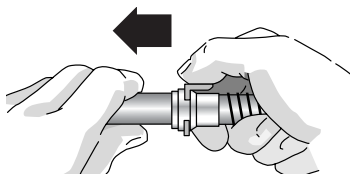

attachment when required. The in-line connector must remain securely connected at all times during operation and patient connection. **Do not separate in-line connector prior to clamping off patient tube clamp.**

■ Patient Tube Clamp

The patient tube clamp provided with *in-line* connector models must remain open at all times during system operation.

It is recommended to move the patient tube clamp next to the in-line connector (closer to chest drain) for set up convenience and routine visual check.

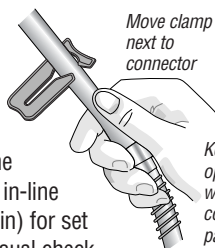

Do not keep patient tube clamp closed when system is connected to patient. Tube clamp must be closed prior to in-line connector separation.

■ Sampling Patient Drainage

Sampling of patient drainage must be in accordance with approved hospital infection control standards. Fluid samples can be taken directly from the patient tube by forming a temporary dependent loop and inserting a 20 gauge or smaller needle at an oblique angle. **Do not puncture patient tube with an 18 gauge or larger needle.**

■ Swing Out Floor Stand

Atrium's floor stand swings open for convenient system set up and secure placement on floor. It is recommended that the floor stand be closed during patient transit or while unit is hung on bed.

■ Multi-Position Hangers

The multi-position hangers are easily lifted from inside the handle. Press hangers into handle when not in use.

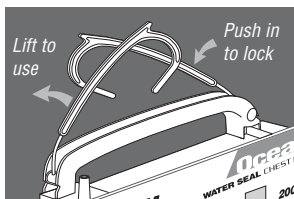

■ Gravity Drainage

For gravity drainage applications, the drain should be placed below the patient's chest in an upright position. Disconnect the suction source vacuum line from the stepped suction line connector or suction control stopcock. **For models equipped with a suction control stopcock it is recommended to leave the stopcock in the ON or OPEN position during gravity drainage.**

■ System Disconnection

For models equipped with an in-line connector, close the patient tube slide clamp prior to disconnecting the chest drain patient tube from the patient. For maximum patient protection, clamp off all indwelling thoracic catheters *prior* to disconnecting the chest drain patient tube from the patient's catheter(s).

Anatomy And Physiology Review

■ Anatomy Of The Chest

The chest wall is composed of the ribs, sternum, and thoracic vertebrae and are all interlaced and covered with intercostal muscle to form a semi-rigid structure. The lower boundary or floor of the thoracic cavity is known as the diaphragm, which is also composed of muscle.

Although the thoracic cavity contains two passageways which are open to the outside environment, the esophagus and trachea, the cavity itself is an enclosed structure. The interior of the thoracic cavity can be divided into three distinct areas: the mediastinum and two separate chambers for each lung. The superior mediastinum consists of soft tissue which encloses the esophagus, trachea, heart, aorta, and other major vessels. The mediastinum acts as a flexible partition which extends from front-to-back and top-to-bottom of the central portion of the chest.

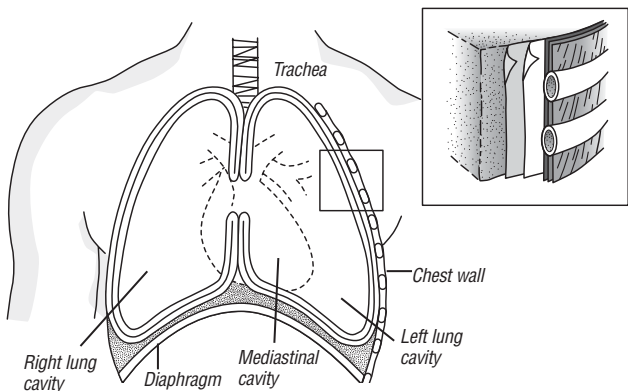

The inside of the rib cage is lined by a membrane called the parietal pleura while the lungs are covered by another membrane called the pulmonary or visceral pleura. Under normal conditions, these two pleural surfaces slide against each other allowing the lungs to expand and contract. These two surfaces are closely held to one another, being separated only by a very thin film of lubricating fluid secreted by the pleura, called pleural fluid.

■ Why The Lungs Are Expanded

A principal factor which keeps the visceral and parietal pleurae together and not separating is vacuum, commonly referred to as negative pressure. This negative pressure, or vacuum, is always present during normal respiration with the membranes closely intact under normal conditions. The presence of negative pressure between these two membranes is what helps hold the visceral pleura in close contact with the parietal pleura at all times. Hence, negative pressure or vacuum around the outside of the elastic lung is what keeps the lung in a fully expanded position, counteracting the lung's normal tendency to shrink in size.

If air, fluid, or blood were to enter the space between these two membranes, the space created is known as a pleural space and is an abnormal occurrence. When this occurs, the lungs can no longer fully expand with each inspiration and intense pain results, inhibiting the voluntary effort of breathing.

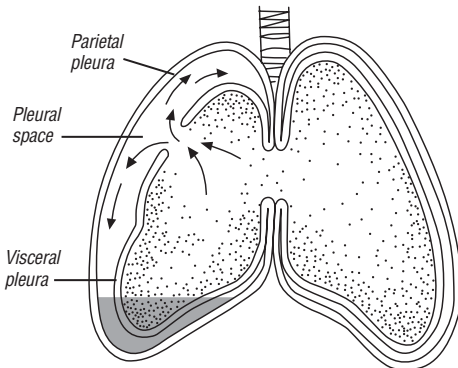

■ The Mechanics Of Breathing

Respiration is the cycle of inspiration and expiration in which air moves in and out of the lungs due to changes in pressure. When the diaphragm is stimulated by the phrenic nerve, it contracts and moves downward. With the help of the external intercostal muscles, the rib cage moves up and out. The lung itself expands because of the movement of the diaphragm and the chest wall. The surface tension of the pleural fluid together with the naturally occurring vacuum pressure induced by the pulling action of the diaphragm is what actually holds the pleural membranes together, thus keeping the lungs fully expanded.

Under normal conditions, there is always negative pressure in the pleural cavity. The degree of negativity, however, changes during respiration. During normal inspiration, intrapleural vacuum pressure is approximately $-8\text{cmH}_2\text{O}$, while during expiration the vacuum pressure falls to $-4\text{cmH}_2\text{O}$. With deep inspiration, intrapleural vacuum pressures can be even more negative.

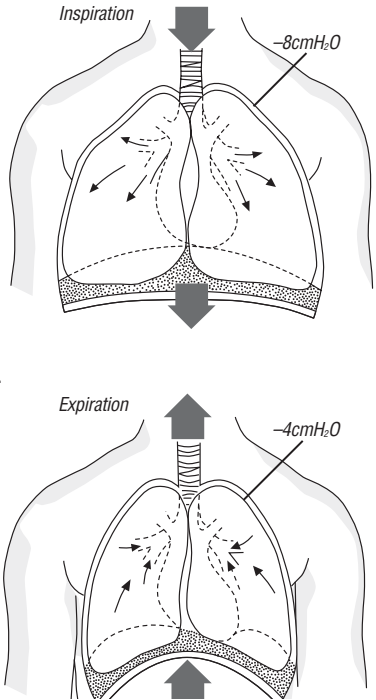

Why Water Seal CDU's Are Used

■ Clinical Needs For Chest Tube Drainage

When the chest wall is opened either by surgery or chest injury, the in-rush of air causes the vacuum in the patient's pleural cavity to escape and atmospheric air to enter the intrapleural space. Since the normal negative pressure or vacuum is no longer present, the lungs collapse as they depend upon this negativity or vacuum to stay fully expanded up against the inside of the chest wall. When air enters or becomes trapped inside the chest causing a pleural space, the lungs cannot fully expand, and the patient will experience difficulty in breathing. This condition is known as a *pneumothorax*. This is a frequent occurrence after all thoracic and cardiac surgeries, as well as with most chest wall injuries. Very often there is a combination of both air and blood present in this abnormal space, causing a similar effect on breathing. When blood collects in the patient's pleural space, it is known as a *hemothorax* and when there is the combination of both blood and air, it is known as a *hemopneumothorax*.

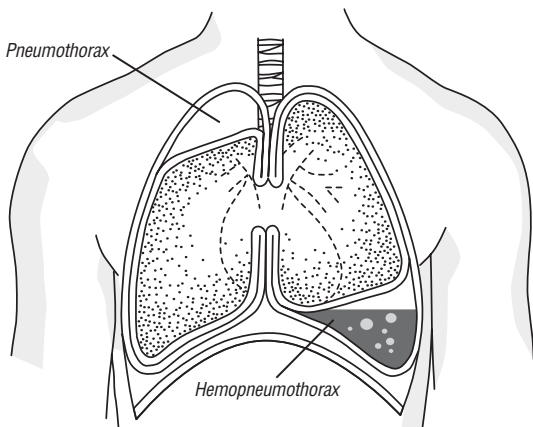

Tension pneumothorax is a more serious complication that can develop when air continues to leak from a hole in the lung directly into the pleural space and has no way to escape. As more and more air accumulates in the pleural space, pressure within this space rises significantly. If the pressure within builds up enough, it causes a *mediastinal shift*, which means that the entire mediastinal area, including the heart and other structures, can be pushed toward the unaffected side. This reduces the size of the unaffected lung chamber, making it very difficult to breathe. A mediastinal shift can also be significant enough to collapse the unaffected lung to a measurable degree and interfere with normal heart activity. When the compressed lung becomes collapsed as a result of a tension pneumothorax condition, a life-threatening situation develops which requires immediate attention. Early signs of mediastinal shift may include an over-expanded chest, shallow gasping respiration, a shift of the trachea in the suprasternal notch, and changes in arterial pulse. Any one or all of these signs require prompt attention and emergency action by the nurse and/or physician. Normally, this would be accomplished with a procedure known as a thoracostomy.

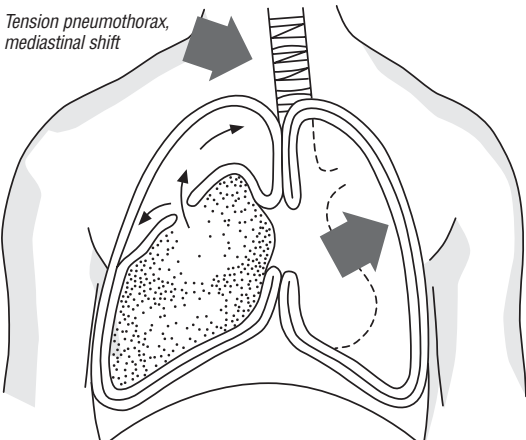

Other conditions in the pleural cavity that may require chest drainage intervention are pleural effusion and empyema. *Pleural effusion* is the accumulation of fluid within the pleural cavity. The presence of lymph fluid is called chylothorax and is often clear, serous fluid. *Empyema* is a pleural effusion that involves purulent material in the pleural cavity and is often caused by pneumonia, lung abscess, iatrogenic contamination of the pleural cavity, or injury.

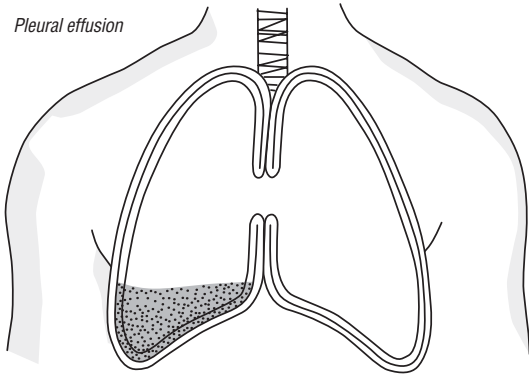

Mediastinal drainage is routinely required after all heart surgeries, sometimes including pleural drainage. Mediastinal drainage is required to prevent the accumulation of blood and clots from taking up space in and around the pericardiac sac. If blood were left to accumulate in the mediastinal cavity, it would cause *cardiac tamponade*, resulting in cardiac distress and death.

The physician's prescribed treatment for any of these clinical drainage situations are:

1. To remove the fluid and air as promptly as possible.
2. To prevent evacuated air and fluid from returning into the chest cavity.
3. To expand the lungs and restore the negative pressure in the thoracic cavity back to its normal level.

Problems To Check For During CDU Use

Very often, potential problems can be avoided by routinely checking the patient, tube connectors, and drainage system at regularly scheduled intervals. Listed below are many of those common problems that can be easily corrected:

- clot in chest tube *inside* patient
- clot in the patient tube
- dependent loop in patient tube with fluid
- kink in patient tube from bed rail or patient position
- partial dislodgement of catheter from patient
- partial disconnection of patient tube from chest tube connector
- overfilled water seal (water is above 2cm line)
- in-line connectors not properly secured
- patient tube clamp may be closed
- floor stand is not fully opened
- chest drain is not upright
- chest drain is not positioned sufficiently below patient's chest
- suction control is not bubbling due to insufficient suction regulation or poor connection
- suction control is bubbling too vigorously

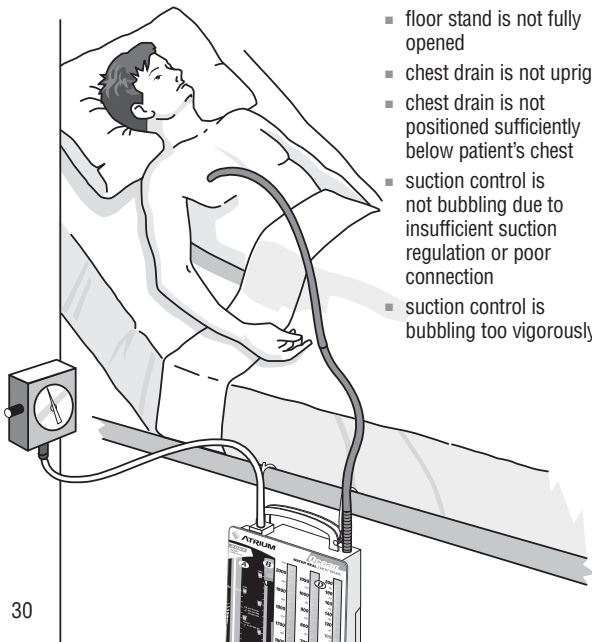

Chest Tube Placement

■ Chest Tube Insertion

To facilitate air and fluid evacuation post surgically, the surgeon will insert a catheter or *thoracotomy chest tube* so that the chest tube eyelets are located inside the chest wall. The surgeon will usually suture the catheter loosely in place to facilitate removal later on. Frequently two catheters are inserted, in which case one is placed near the apex to remove air while the other is placed in the lower part of the chest to remove any pooled blood.

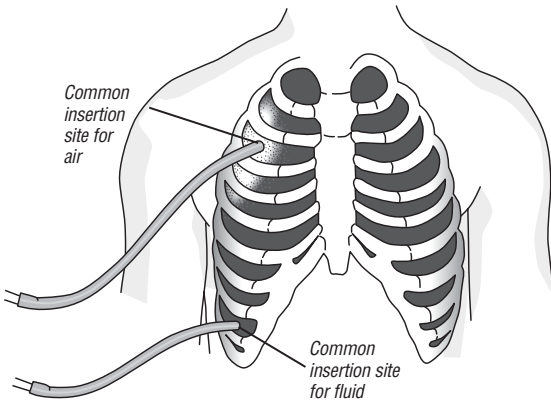

Thoracotomy chest tubes are normally flexible, kink resistant, clear catheters which are inserted through the chest wall via a small incision. A tight intercostal fit is preferred to minimize small bleeders around the catheter and to maintain an airtight seal. A radiopaque stripe helps the clinician identify catheter placement and location of the “catheter eyes” during X-ray for maximum drainage efficiency.

8FR-12FR	Infants, young children
16FR-20FR	Children, young adults
24FR-32FR	Most popular adult sizes
36FR-40FR	Larger adult sizes

**Typical
Chest Tube
Sizes**

■ Chest Tube Nursing Responsibilities

After chest tube insertion, the connector end of the catheter is cut to length and the chest drain stepped connector is inserted. Such connections are often secured with nylon bands for added security and to assure an air-tight tubing connection.

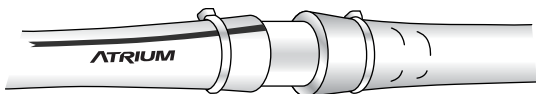

Bands for added security

Since two or more indwelling chest tubes are frequently attached to a single chest drain via a “Y” connector set up, it is important to ensure that all indwelling catheters are properly tailored so as to not kink.

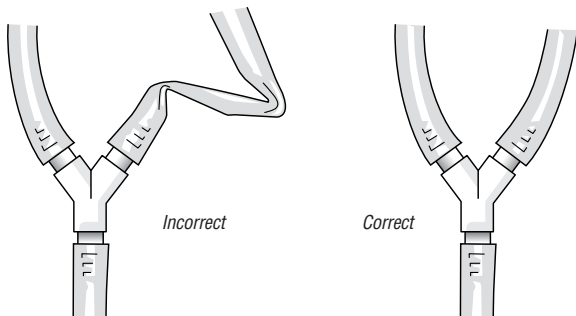

It is important to check the chest tube connections for signs of air leaks, such as “hissing” sounds or bubbling in the water seal. Also check the chest tube dressing and condition of the tube itself, such as position or clotting in the tube. If a tube accidentally pulls out, the insertion site should be quickly sealed with a petroleum gauze dressing to prevent air from entering the pleural cavity. The physician should be notified to assess the patient’s condition and to determine whether or not a new tube will need to be inserted bedside.

Troubleshooting Guide

Q How do I confirm my patient has an air leak when there is:

■ **No bubbling in the water seal?**

A If there are *no air bubbles observed going from right to left in the air leak monitor*, there is no patient air leak. In order to confirm that your patient's chest catheter(s) are patent, temporarily turn suction off and check for oscillation of the patient pressure float ball in the water seal column coinciding with patient respiration.

■ **Bubbling present in the water seal?**

A Whenever *constant or intermittent bubbling* is present in the water seal air leak monitor, this will confirm an air leak is present. Oscillation of the patient pressure float ball at the bottom of the water seal *without bubbling* will indicate no apparent air leak. Bubbling from right to left must be present to confirm an air leak. To determine the source of the air leak (patient or catheter connection), **momentarily** clamp the patient tube close to the chest drain and observe the water seal. If bubbling stops, the air leak may be from the catheter connections or the patient's chest. Check the catheter connectors and patient dressing for a partially withdrawn catheter. If bubbling continues after temporarily clamping the patient tube, this will indicate a system air leak requiring system replacement.

Q What does it mean when the small float ball is located at the bottom of the water seal column?

A If the small float ball is located and oscillating at the bottom of the water seal column *with no bubbling*, there is no apparent patient air leak. However, the water seal should be carefully monitored for the presence of an *occasional* or *intermittent* air leak.

Q How do I lower the water seal level?

A Changes in your patient's intrathoracic pressure will be reflected by the height of the water in the water seal column. These changes are usually due to mechanical means such as milking or stripping patient drainage tubes, or simply by deep inspiration by your patient after all air leaks have subsided. If desired, the height of the water column and patient pressure can be reduced by temporarily depressing the filtered manual vent located on top of the drain, until the float valve releases and the water column lowers to the desired level. **Do not lower water seal column when suction is not operating, or when patient is on gravity drainage.**

Q What happens when the water rises to the top of the water seal float valve?

A The water seal column is a diagnostic manometer for monitoring your patient's intrathoracic pressure. When intrathoracic pressures increase, causing the water to rise to the top of the water seal float valve, the ball floats up and "seats" up against a curved valve seat. This valve seat has been carefully engineered to allow a

certain amount of water to pass through it during a precise amount of time. When vacuum pressures greater than $-20\text{cmH}_2\text{O}$ on gravity or $-40\text{cmH}_2\text{O}$ on suction occur for an *extended period of time*, water will pass through the valve and float valve to allow the water seal to release *automatically*. The

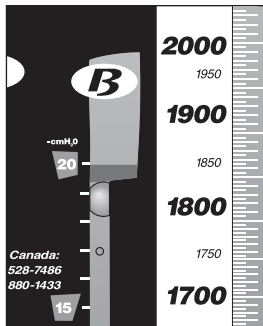

benefit to Atrium's *controlled release* design is that during normal or deep inspiration, the float valve will float up and down with each respiratory cycle, not allowing the water seal to release. This enables thoracic patients to draw as much intrathoracic pressure as they may require during each respiratory cycle.

Q Is it normal for the patient pressure float ball to fluctuate up and down (tidal) near the bottom of the water seal column?

A Yes. Once your patient's air leak is resolved, you will generally observe moderate tidaling in the water seal column. Increases in intrathoracic pressure will cause the water level to rise (the ball rises) during patient inspiration and will lower or decrease (the ball drops) during expiration. This diagnostic tool will help to confirm patency of your patient's catheter(s).

Q What happens when:

■ **There is no bubbling in the suction control chamber?**

A Check to be sure the suction tubing is connected to the chest drain and to the wall regulator and the suction source is turned on. Adjusting Atrium's suction control stopcock is required for constant gentle bubbling.

■ **There is vigorous bubbling in the suction control chamber?**

A Vigorous bubbling causes quicker evaporation and produces excessive noise. Constant, gentle bubbling is all that is required to impose the prescribed amount of suction. Available on all models, Atrium's suction control stopcock located on the suction tubing, can be used to adjust bubbling. The suction source regulator can also be adjusted to turn suction control bubbling up or down.

Q How can I connect multiple chest drains to one suction source easily?

A With Atrium models equipped with a suction control stopcock, connection of two or more chest drains to a common suction source is made easier. Place a 1/4" x 1/4" x 1/4" Y connector on the wall suction tubing. Cut the drain suction tubing where indicated in *Illustration 1*. Now invert the cut sections of suction tubing as shown in *Illustration 2* and insert them into the suction tubing remaining on the chest drain.

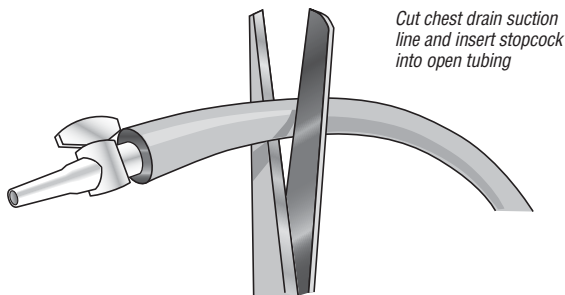

Illustration 1.

Now you have two open ends of suction line tubing for the Y connector to be placed. Turn on suction and adjust Atrium's suction control stopcock on each drain to achieve constant, gentle bubbling with each.

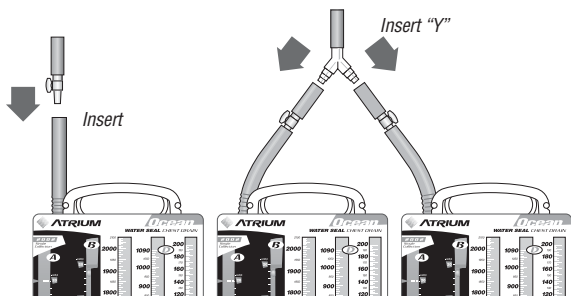

Illustration 2.

Q Should the suction control stopcock be turned off for gravity drainage or for patient transport?

A No. The patient is protected two ways: first by the one-way valve created by the water seal to maintain the desired patient vacuum pressure, and second, the patient is protected by the integral positive pressure valve in the event the stopcock is turned off. It is not necessary to turn off the stopcock, clamp, or cap the

suction line during gravity drainage or patient transport. Both the water seal and the positive pressure valve provide maximum patient protection when either the suction line or stopcock remain open or closed.

Q Should the manual vent be used during gravity drainage?

A No. It is **not** recommended to depress the manual vent during gravity (no suction) drainage.

Q If the chest drainage system has been knocked over, can I use it and what should I do?

A After a chest drainage system has been knocked over, set it upright and immediately check the fluid levels of the water seal and suction control chambers for proper volumes. Atrium provides convenient, self-sealing diaphragms for access by a 20 gauge or smaller needle and syringe to adjust the water level in each chamber, if required. Alcohol swab the needle access area and aspirate any overflow that may have occurred. If the water seal or suction control chambers have an inadequate fluid level, simply replace the lost volume. If a significant amount of blood has entered the water seal, it may be advisable to change the system for a new one.

Q How do I dispose of the system?

A Disposal of system and contents must be in accordance with approved hospital infection control standards.

Notes





CUSTOMER SERVICE

If a question or need arises for customer service, product information, or to request inservice educational material, we invite you to call or FAX Atrium's hotline anytime.

In the U.S.A. 1-800-528-7486



Outside the U.S.A. 603-880-1433

FAX 603-880-6718

www.atriummed.com



ATRIUM MEDICAL CORPORATION

5 Wentworth Drive
Hudson, New Hampshire 03051 U.S.A.

 603-880-1433  603-880-6718



ATRIUM MEDICAL CORPORATION

Rendementsweg 24, L III
3641 SL Mijdrecht, The Netherlands

 +31-297-230-420  +31-297-230-422

ATRIUM AUSTRALIA-PACIFIC RIM PTY.LTD.

L 1 Bridgepoint
3 Brady Street
Mosman NSW 2088 Australia

 +61-2-9960-0169  +61-2-8969-2735